

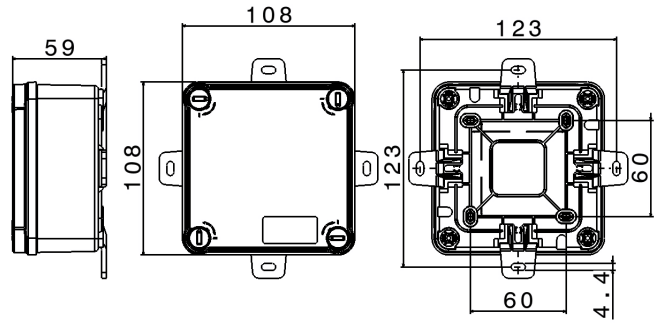

**SERIES TERBOX
ENCLOSURE**
CODE 791234



Datasheet

Electrical characteristics

Insulation Class	II
Rated insulation voltage	-
Rated operating voltage	-
Dissipable Power	-

Mechanical characteristics

Manufacturing material	Technopolymer Recyclable Palazzoli
Treatment type	-
Surface finishing	-
Color	Grey RAL 7035
Execution	Wall mounting
Height Box	44 mm
Cover height	16 mm
Cover type	Blind
N. of modules on DIN rail	-
Hole type	-
Window type	-
IP Protection degree	IP56
Additional IPdegree protection	-
Shock resistance	IK08 according to IEC/EN 62262
Resistance to Glow wire	650°C
Flame rating according UL94	HB
Corrosivity category	-
Working Environment Temp.	Min: -25°C ;Max: +60°C
Warehousing Temperature	Min: -30°C ;Max: +70°C
Dimensions	110X110X60 mm
Internal dimensions	98X98X49 mm
Net Weight	0.14 KG

Reference Standards and Directives

Certification and approval marks CE, UKCA

Directives 2014/35/EU (LVD)

Reference Standards EN 60670-1:2005, EN 60670-1:2005/A1:2013, EN 60670-1:2005/AC:2007, EN 60670-1:2005/AC:2010, EN 60670-22:2006

The images are purely indicative. Palazzoli reserves the right to make changes without notice.